



IEC 309 HP: range of plugs and socket-outlets compliant with international Standards IEC 60309-1 and IEC 60309-2, assimilated at European level as EN 60309-1 and EN 60309-2. This range expands the GEWISS assortment of mobile plugs, mobile and recessed sockets for currents from 16 to 125A with IP44 / IP54 protection ratings and ratings up to IP66 / IP67 / IP68 / IP69 to ensure total protection in all possible applications. The technopolymers and thickness used for the parts made of insulating material guarantee an elevated degree of mechanical and chemical agent resistance. All the sleeves and pins of the IEC 309 HP socket-outlets and plugs are surface-treated with nickel-plating to ensure full protection against corrosion, oxidation and abrasion. All the external metallic elements of the IEC 309 HP plugs and socket-outlets are made of stainless steel (the threaded metallic inserts for the body-grip coupling of the 63-125A versions are made of brass).

| | | | |
|---------------------------------|---|------------------------------|--|
| Colour | Red | Rated current (A) | 16 |
| IP degree | IP66/IP67/IP68/IP69 | No. of poles | 3P+E |
| Mechanical resistance | IK09 | Reference h | 6 |
| Type | Straight connector | Rated voltage | 380 - 415 V |
| Frequency | 50/60 Hz | Terminal tightening capacity | 1-2.5mm ² flexible cables - 1.5-4mm ² rigid cables |
| Cable clamp tightening capacity | 7.5-13.8 mm | Operating temperature | -25 +55 °C |
| Type of wiring | With screw | Type of material | Halogen-free in compliance with EN 60754-2 |
| Electrocod | 2211 | Glow wire test | 850 °C (active parts) - 650 °C (passive parts) |
| Total number of operations | > 5000 | Permissible overload | 22 A |
| Breaking capacity at 1.1 Un | 20 A | Insulation resistance | > 10 MΩ |
| Thermo-pressure with ball | 125 °C (active parts) - 80 °C (passive parts) | | |

BEHAVIOUR WITH CHEMICAL AND ATMOSPHERIC AGENTS

| Saline solution | Acids | | Bases | | Solvents | | | | Mineral oil | UV rays |
|-----------------|---------------|--------------------|--------------------|-----------|-----------|-----------|-----------|------------|-------------|-----------|
| | Concentrated | Diluted | Concentrated | Diluted | Hexane | Benzol | Acetone | Alcohol | | |
| Resistant | Not resistant | Limited resistance | Limited resistance | Resistant | Resistant | Resistant | Resistant | Resistente | Resistant | Resistant |

DIMENSIONAL

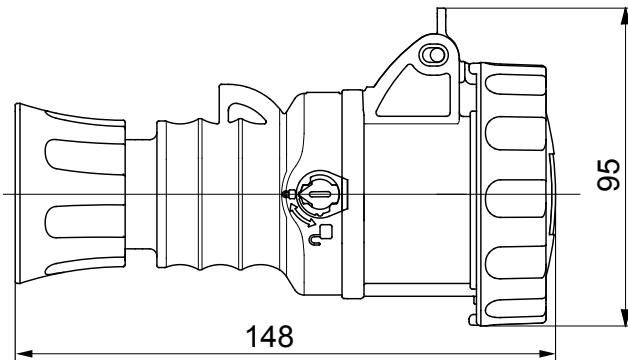

TECHNICAL SYMBOLOGY

| | | | | | | |
|----------------------------------|-------------------|--|-------------------|---|--|---|
| IP IP66/IP67/IP68/IP69 | IK IK09 | INSTALLATION -25°C min / +55°C max -25 +55 °C | With screw | HF HALOGEN FREE Halogen-free in compliance with EN 60754-2 | GWT 850 °C (active parts) - 650 °C (passive parts) | Thermo-pressure 125 °C (active parts) - 80 °C (passive parts) |
|----------------------------------|-------------------|--|-------------------|---|--|---|

STANDARDS/APPROVALS

