

WISKA COMBI 1010

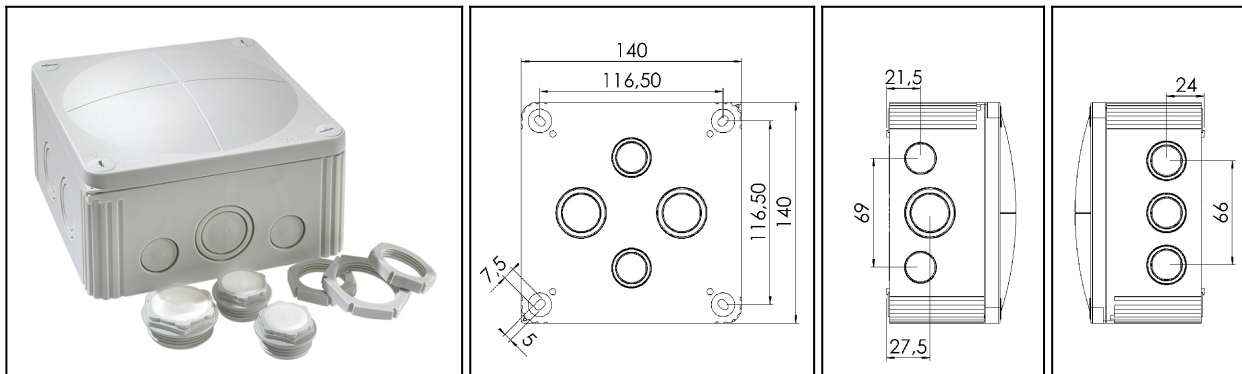

Protection class to EN 60 529:

IP 66 / 67

Flame protection:

Glow wire test 750° C acc. to EN 60695-2-11

Temperatures during installation:

-5°C to 60°C

Temperature range of material:

-30°C to 100°C, intermittent up to approx. 120°C

Voltage:

690 V

Material:

Polypropylene, reinforced; sealing: thermoplastic elastomere

Terminals/poles:

10 mm²

Fixing:









4 internal openings outside of the sealing area

Equipment:

- 10 knockout entries at the side (5xM 25/32, 2xM 20, 3xM 20/25)
- 4 knockout entries (2xM 25/32, 2xM2 0/25) in the base
- 4 captive quick-release lid screws
- Colour RAL 7035 light grey
- .../S = black
- .../W = white
- Incl. self-sealing membrane screws QUIXX-EMS, 2 x M 25, 1 x M 32

Accessories:

DIN RAIL KIT 1010: Rail TS 35 + Fixing material, WISKA-No. 10060363

Type	WISKA-No.			L x B x H external / außen mm
COMBI 1010/leer	10060702	2		140 x 140 x 82
COMBI 1010/leer/S	10062214	2		140 x 140 x 82
COMBI 1010/leer/W	10062210	2		140 x 140 x 82
COMBI 1010/5	10060703	2		140 x 140 x 82
COMBI 1010/5/S	10062215	2		140 x 140 x 82
COMBI 1010/5/W	10062211	2		140 x 140 x 82
DIN RAIL KIT 1010	10060363	1	—	-