

Product Code: QCT50-8

Luckinslive 399413984

Description: 50mm² Copper Tube Lug With 8mm Stud

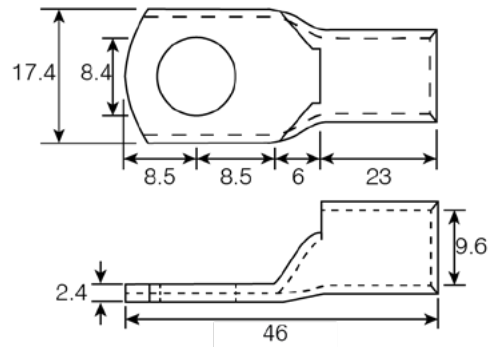

Dimensions

Stud Size (mm)	8
Overall Length (mm)	46
Bellmouth Length (mm)	23
Bellmouth Internal Diameter (mm)	9.6
Stud Entry Diameter (mm)	8.4
Overall Width (mm)	17.4
Terminal Thickness (mm)	2.4
Stud Centre From Front (mm)	8.5
Stud Centre From Rear (mm)	8.5
Bellmouth To Terminal (mm)	6

General Information

Contact Plating (Microns)	5 to 8
Flared Entry	Yes
Conductivity	97% to IACS
Inspection Window	Yes
Fixing Type	Suitable for crimp or solder
Working Temperature (°C)	<180

Materials

Material: Tin Plated Copper Tube

Additional Information

When using flexible fine strand or welding cable it may be necessary to select the next larger terminal size, i.e 70mm² fine strand, select 95mm² terminal.

Standards

ANSI/UL 486A-486B, CAN/CSA-C22.2 No. 65
ANSI/UL 486C, CSA-C22.2 No. 188
Tensile performance requirements to IEC 61238-1-1: 2018

