

Product Code: QCT70-6

Luckinslive 402621809

Description: 70mm² Copper Tube Lug With 6mm Stud

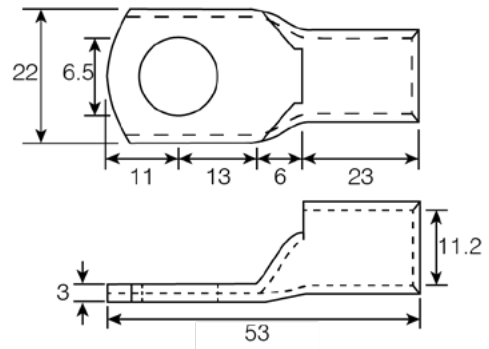

Dimensions

Stud Size (mm)	6
Overall Length (mm)	53
Bellmouth Length (mm)	23
Bellmouth Internal Diameter (mm)	11.2
Stud Entry Diameter (mm)	6.5
Overall Width (mm)	22
Terminal Thickness (mm)	3
Stud Centre From Front (mm)	11
Stud Centre From Rear (mm)	13
Bellmouth To Terminal (mm)	6

General Information

Contact Plating (Microns)	5 to 8
Flared Entry	Yes
Conductivity	97% to IACS
Inspection Window	Yes
Fixing Type	Suitable for crimp or solder
Working Temperature (°C)	<180

Materials

Material: Tin Plated Copper Tube

Additional Information

When using flexible fine strand or welding cable it may be necessary to select the next larger terminal size, i.e 70mm² fine strand, select 95mm² terminal.

Standards

ANSI/UL 486A-486B, CAN/CSA-C22.2 No. 65
ANSI/UL 486C, CSA-C22.2 No. 188
Tensile performance requirements to IEC 61238-1-1: 2018

